

ALL DIMENSIONS IN MM

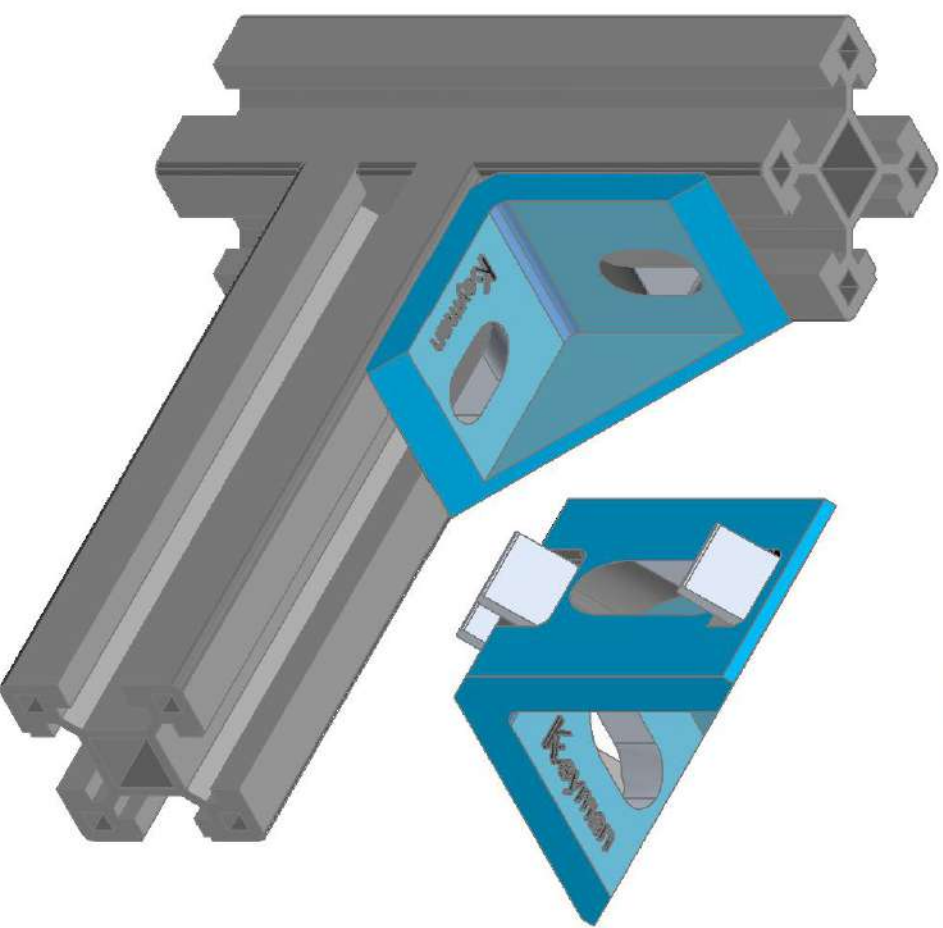
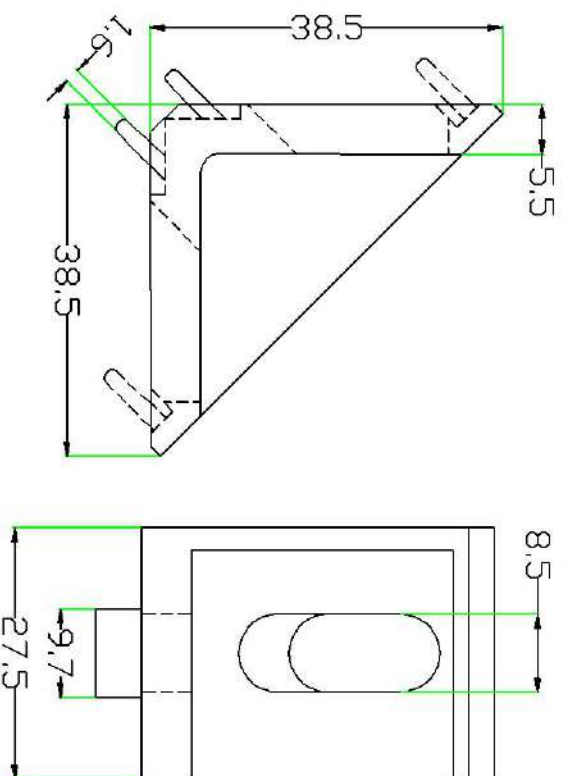

APPLICATION DRAWING FOR MODEL  
NO. KAP 29.1 (ANGLE BRACKET 30/40)